

63 A

1 000 V

U MAXI

DECONTACTOR™ DSN6



IP66
IP67
IP69



6-16 mm² (1)
10-25 mm² (2)



GRP



IK09



-40 °C
+60 °C



AC-22
AC-23



60309-1
60309-4
60947-3



4 AUX (3)

(1) Flexible wiring (min.-max.).
(2) Stranded wiring (min.-max.).
(3) Flexible wiring : 1-2,5 mm²,
stranded : 1,5-4 mm²



**Other cable sections:
please contact us**



**For a black colour
housing replace the second
reference character with 5.**

LOAD-BREAK CAPABILITY OF THE DECONTACTOR™

Comply with IEC/EN 60309-1 and IEC/EN 60309-4 standards	(63 A/690 V) or (45 A/1000 V)
Load-break capability according to IEC/EN 60947-3/AC-22	40 A/690 V
Load-break capability according to IEC/EN 60947-3/AC-23	63 A/400 V
Short-circuit current I _{cc}	10 kA
Power kW AC-22/AC-23	30 kW

SOCKET-OUTLET

female
DSN6













INLET male
DSN6























**Dual-voltage
socket-outlet
(see p. 11)**

20-24 V AC	2P	616408A	616808A
190-230 V AC	3P+E	6164033	6168033
220-250 V AC	1P+N+E	6164015	6168015
380-440 V AC	3P+E	6164013	6168013
220-250 V AC 380-440 V AC	3P+N+E	6164017	6168017
660-690 V	3P+E	6164193	6168193
380-400 V 660-690 V	3P+N+E	6164197	6168197
Auxiliaries 16 A/400 V AC	+ 2 contacts	Ref. + 972	Ref. + 972
Auxiliaries 16 A/400 V AC	+ 4 contacts	Ref. + 264	Ref. + 264











► Other currents, voltages, frequencies and contact configurations are available (see page 14).

OPTIONS	Reference
LOCKING PIN FOR 2 PADLOCKS Ø 4 TO 8 mm (PADLOCK NOT SUPPLIED)	
 Socket-outlet ref. +843	
SAFETY HASP FOR UP TO 6 PADLOCKS	
 613A541	
LARGER RELEASE BUTTON	
 Ref. socket +453	
INLET CAP IP66/IP67	
 616A426	
IN-LINE CONNECTIONS (A PAIR OF FINGER DRAW PLATES TO AID CLOSING)	
 616A346	
180° OPENING LID	
 Ref. socket +10	
IP40 SELF RETURNING LID (MANUAL CLOSING)	
 Socket-outlet ref.+R	
180° OPENING + SELF-RETURNING LID	
 Ref. socket +18	
IP55 METAL LOCKABLE SELF-CLOSING LID FOR INLET	
 616A226	
SELF-EJECTION	
 See page 186	
PRODUCTS AVAILABLE IN BLACK ●	
The black dot means these products are also available in black color. Replace the second character of the product reference with 5	

SLEEVE		Reference
POLY SLEEVE ●		
 30°		513M3
 70°		513M7
METAL SLEEVE		
 0° (Straight)		593M0
 30°		593M3
 70°		593M7

BOXES *		Input	Reference
POLY BOX ●			
 30°		M25	513B3M25
METAL BOX (+ EARTHING WIRE)			
 20°		M20	593B2M20
 20°		M25	593B2M25
 20°		M32	593B2M32
POLY BOX + POLY SLEEVE (BLACK VERSION SEE ACCESSORIES DXN6 PAGE 247)			
 70°		Without hole	513C7000
 70°		Hole Ø 25	513C7M25
 70°		Hole Ø 32	513C7M32
 70°		Hole Ø 40	513C7M40
METAL BOX (+ EARTHING WIRE) + POLY SLEEVE			
 30°		M20	513C3M20
 30°		M25	513C3M25
 30°		M32	513C3M32
 30°		M40	513C3M40
METAL BOX (+ EARTHING WIRE) + METAL SLEEVE			
 30°		M20	593C3M20
 30°		M25	593C3M25
 30°		M32	593C3M32
 30°		M40	593C3M40
 0° (Straight)		M20	593C0M20
 0° (Straight)		M25	593C0M25
 0° (Straight)		M32	593C0M32
 0° (Straight)		M40	593C0M40
 70°		M20	593C7M20
 70°		M25	593C7M25
 70°		M32	593C7M32
 70°		M40	593C7M40

* Cable glands are not delivered with the boxes.

HANDLE	Input/ Cable outer Ø	Reference	Self-ejection
POLY HANDLE WITH GLAND ●			
 10-30 mm		513P0D30	/
POLY HANDLE + POLY CABLE GLAND ●			
 5-12 mm		513P020P	Ref. +443
 9-18 mm		513P025P	Ref. +443
 14-25 mm		513P032P	Ref. +443
 18-32 mm		513P040P	Ref. +443
METAL HANDLE WITH METAL GLAND (+ EARTHING WIRE)			
 7-13 mm		593P020M	/
 8-16 mm		593P025M	/
 16-24 mm		593P032M	/
 22-32 mm		593P040M	/
POLY HANDLE (WITHOUT CABLE GLAND) ●			
 M20		513P0M20	Ref. +443
 M25		513P0M25	Ref. +443
M32		513P0M32	Ref. +443
M40		513P0M40	Ref. +443
METAL HANDLE METRIC THREAD ENTRY (WITHOUT CABLE GLAND)			
M20		593P0M20	/
M25		593P0M25	/
M32		593P0M32	/
M40		593P0M40	/

DRAWINGS AND DIMENSIONS

PLUG ON SOCKET-OUTLET

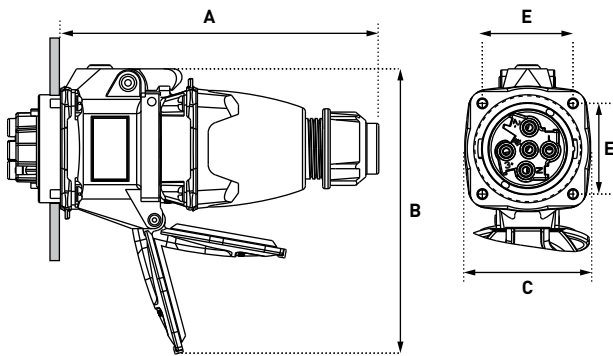

A	B	C	E
184	195	84	55

COUPLER

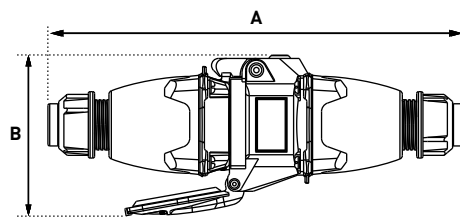

A	B
286	122

PLUG ON 30° WALL MOUNTED SOCKET OUTLET

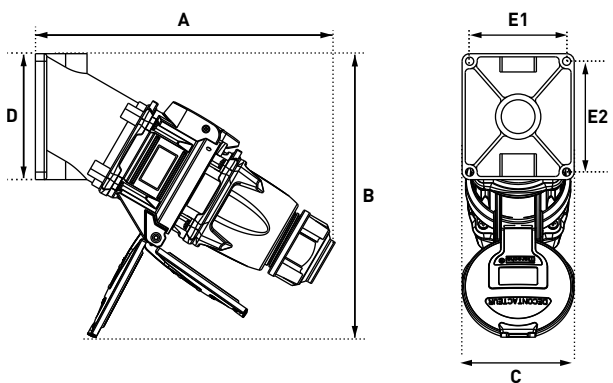

A	B	C	D	E1	E2
238	225	89	100	77	88

PLUG ON 70° WALL-MOUNTED SOCKET-OUTLET

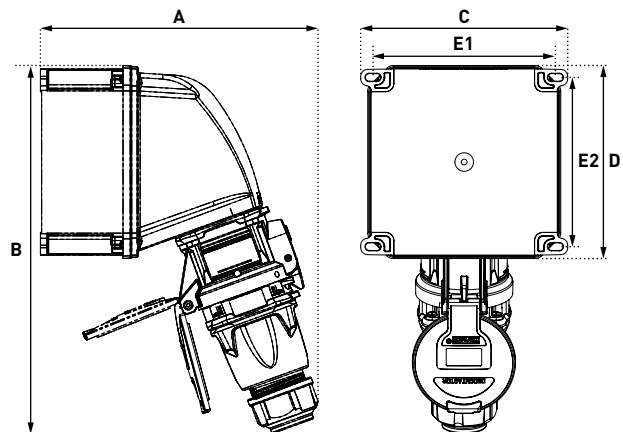

A	B	C	D	E1	E2
239	317	178	166	157	146

PLUG ON 30° INCLINED SOCKET-OUTLET

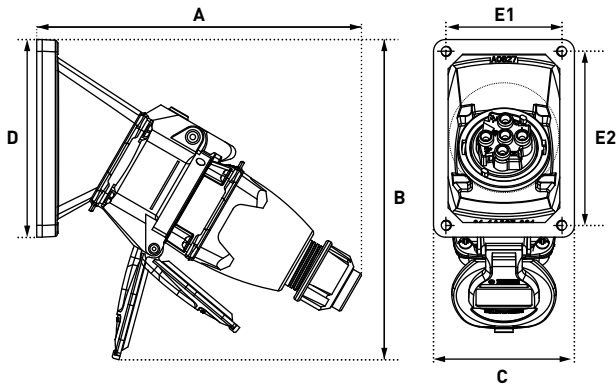

PLUG ON 70° INCLINED SOCKET-OUTLET

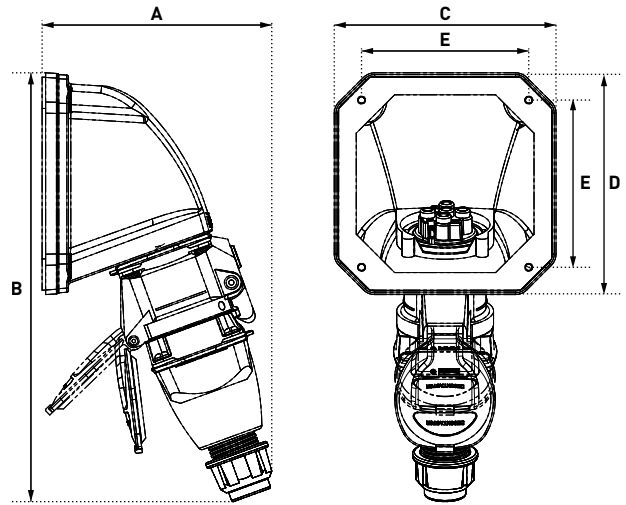

A	B	C	D	E1	E2
212	219	77	108	63	95

A	B	C	D	E
170	317	166	166	135

