



EVO

The first separable
switch-disconnector



 **MARECHAL**
ELECTRIC



SUMMARY

EVO

A UNIQUE PRODUCT.

Once again, **MARECHAL ELECTRIC** is at the heart of innovation with the invention of the first separable switch-disconnector.

For even more safety, **EVO** facilitates the compliance of your machines and equipments.

Discover "**EVO**", our new ergonomic and modern invention, created for you.

EVO TWIST & SWITCH	3
ITS PARTICULARITY	4
ITS USE	5
ITS CONFIGURATIONS	6
ITS APPLICATIONS	7
ITS ADVANTAGES	8
ITS TECHNOLOGY	9
TECHNICAL CHARACTERISTICS	10
PART NUMBERS	11



EVO TWIST & SWITCH

A SEPARABLE
SWITCH-
DISCONNECTOR



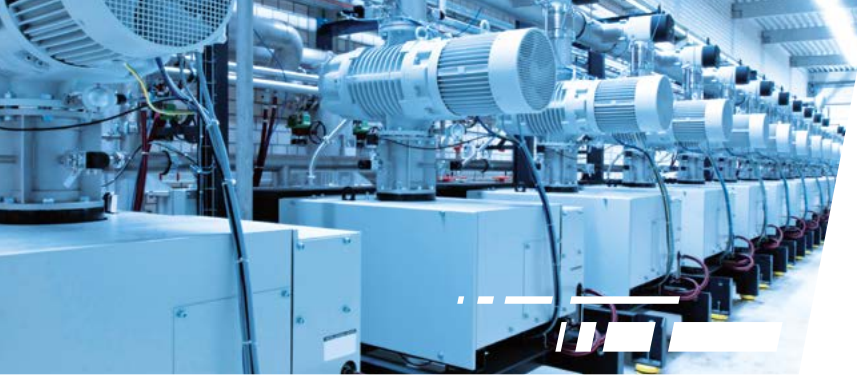

ITS PARTICULARITY

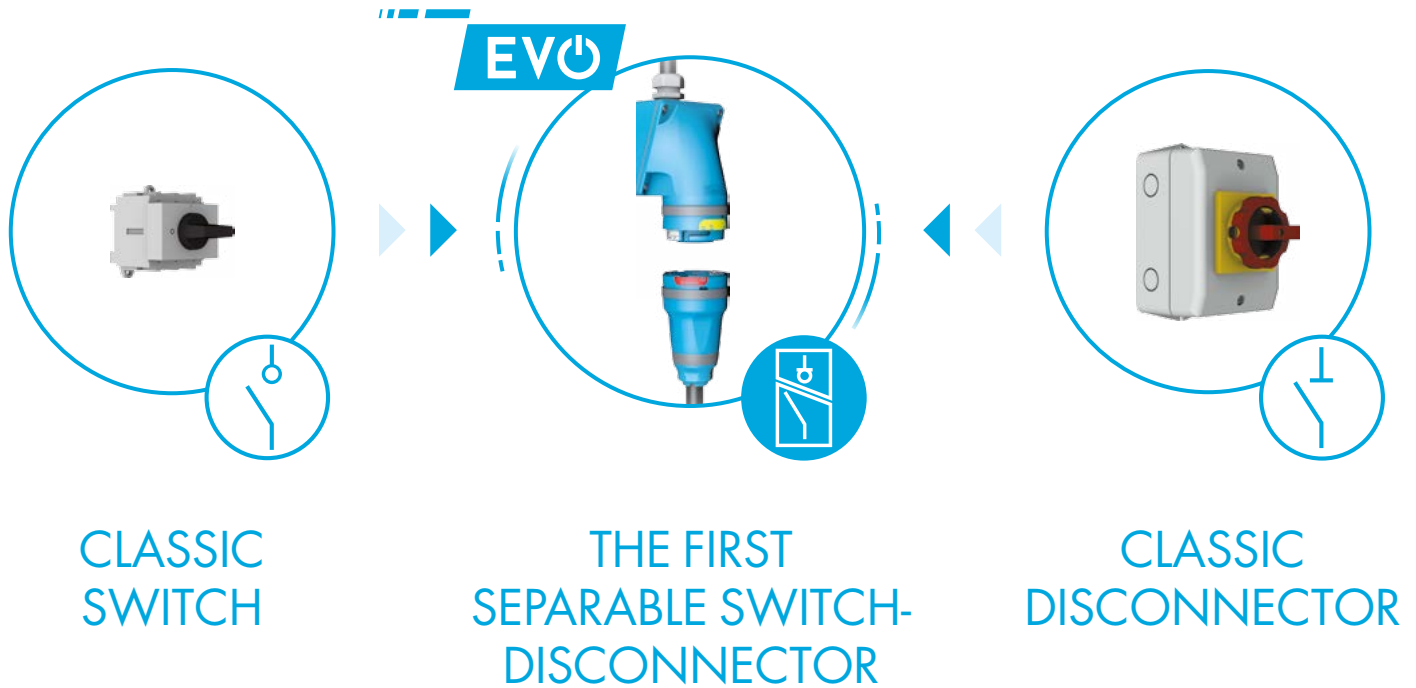

TWIST & SWITCH

POSITIVE AND CLEARLY VISIBLE BREAKING

AUTOMATIC IP66/IP67 WATERPROOFING IN THE ON AND OFF POSITIONS

SLEEK DESIGN

REDUCES SPACE REQUIREMENTS

REDUCES INSTALLATION COSTS AND DOWNTIMES

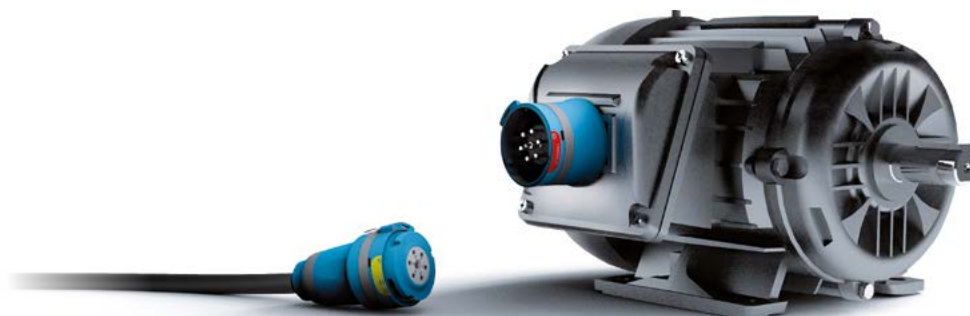

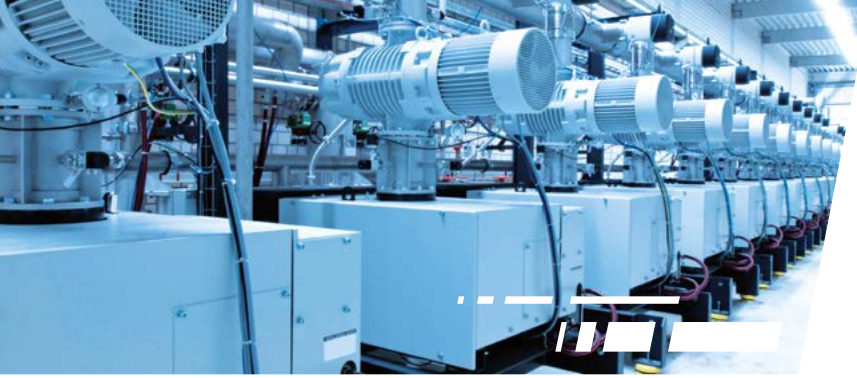

LOAD BREAK ROTARY SWITCH

- Simple operation
- Waterproof in ON and OFF positions

Separated position



Position 00

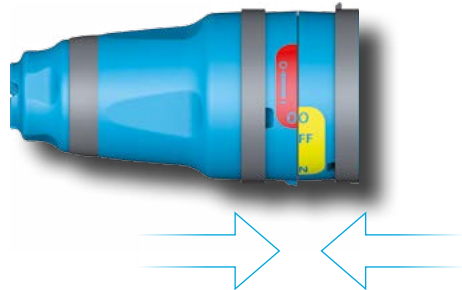

Position OFF

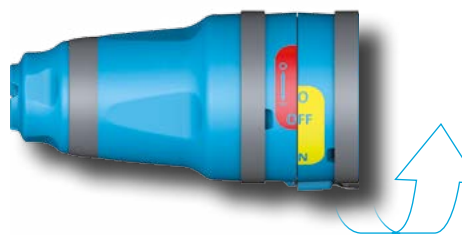

Position ON





ITS CONFIGURATIONS

EVO

POSSIBLE INSTALLATIONS

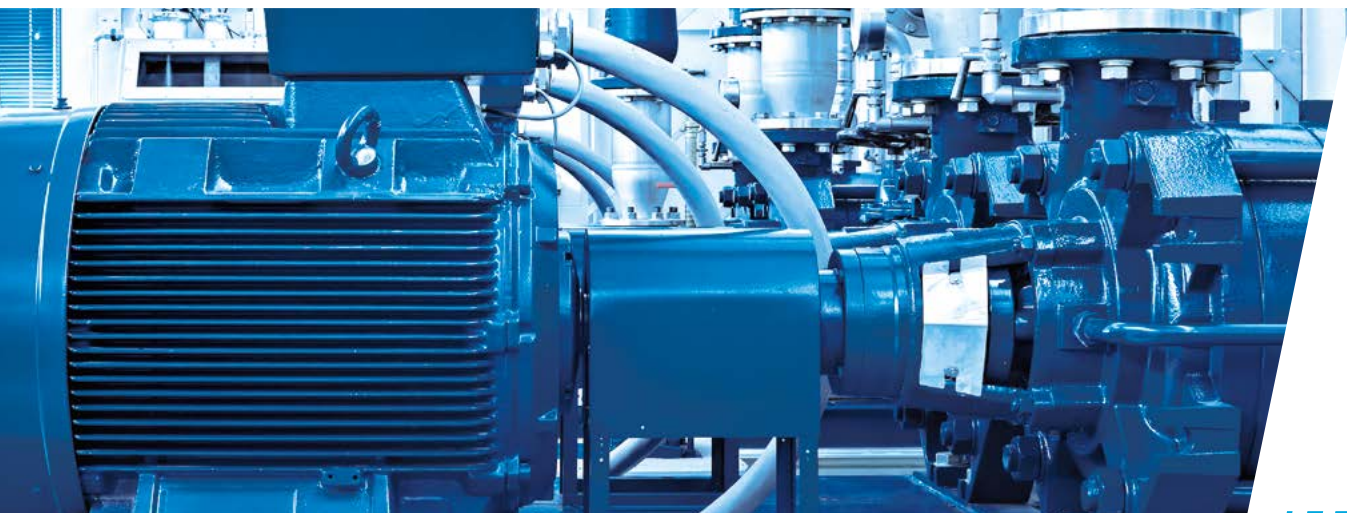



ITS APPLICATIONS

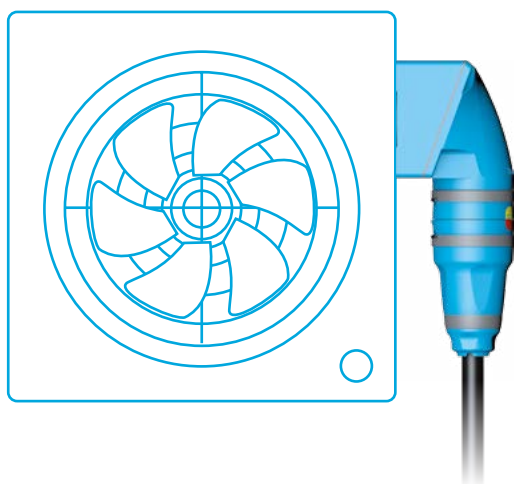

EVO40 is particularly appropriate for all industrial applications such as motor power supply.

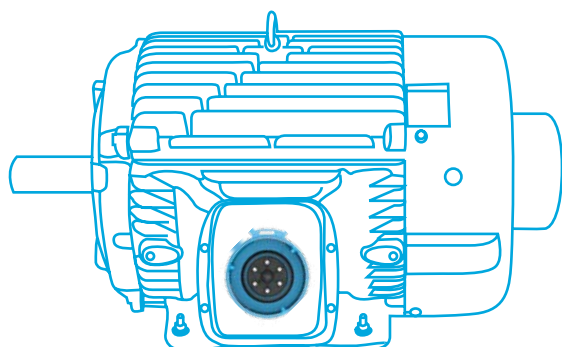
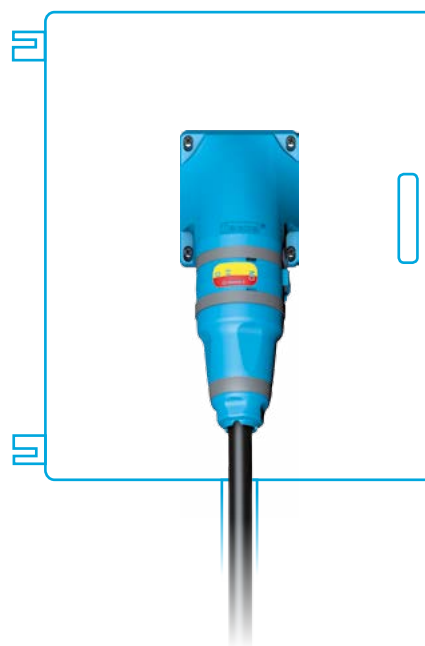

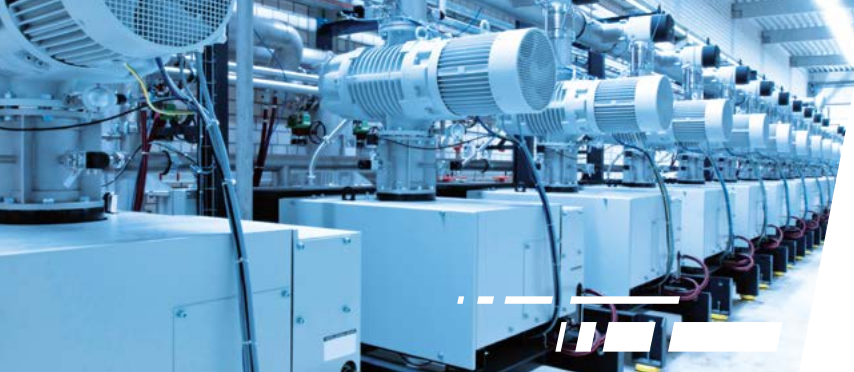

ITS ADVANTAGES

KEY FEATURES

THE BENEFITS

Separable switch-disconnector	Simplification and economy
Positive and visible breaking	100% ensured safety
Disconnection speed independent of operator use	Reliability Ease of use
Automatic IP66/IP67 sealing in ON and OFF positions and with cap	Suitable for harsh industrial environments
IP4X on source side	User safety and compliance with standards
Smooth crevice free design, no visible fixing screws	Easy to clean
Up to 6 poles + earth	Ability to connect power and/or control signals
Surface mounting dimension limited to 120 mm	Compact design (50° or 90° version wall box)

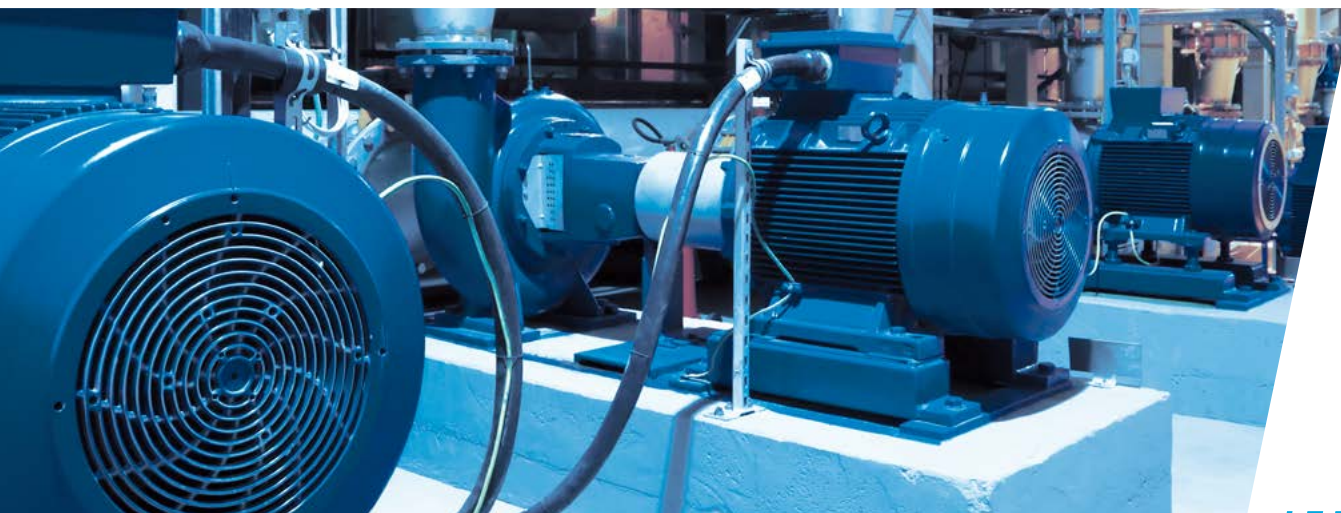

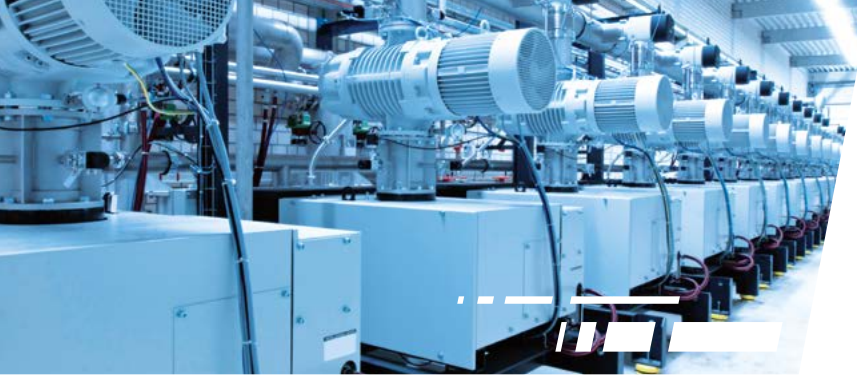

ITS TECHNOLOGY

Double break per pole
AC-22A/AC-23A (18,5 kW)
AC-3 (11 kW)

Cage terminals improving conductivity
and vibration resistance

Colour Coded terminals
1, 2, 3, 4/N, 5, 6

Ergonomic handle
Screwless fixings

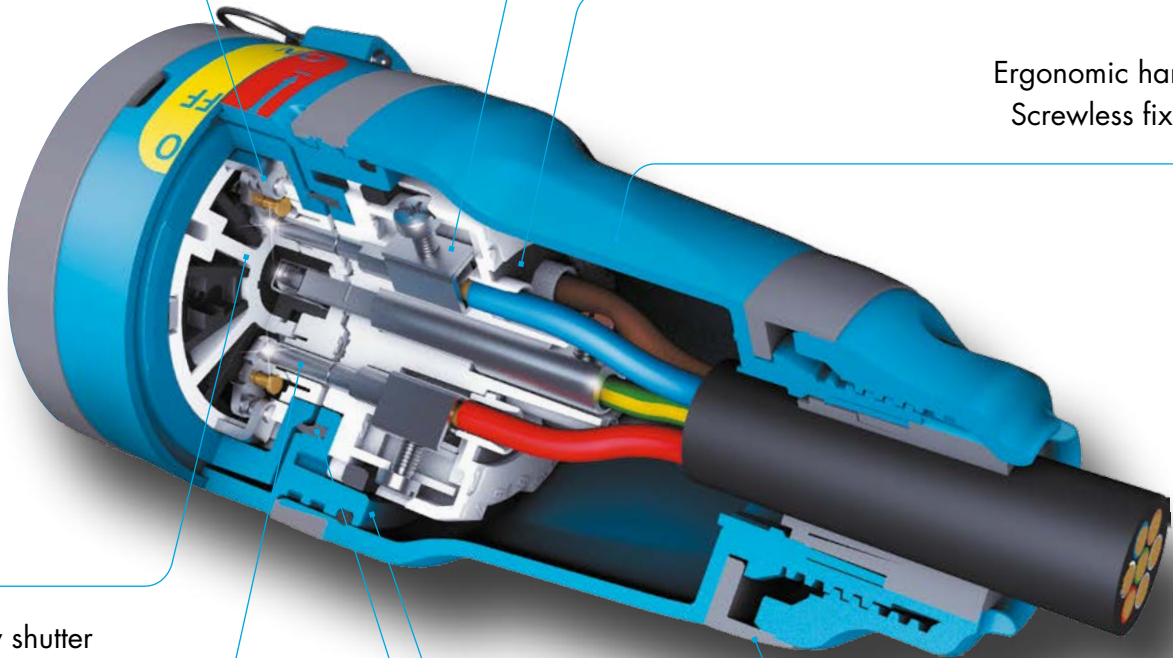

IP4X safety shutter
Protection from live
parts

Contacts on silver alloy
tips (anti-corrosion
treatment)

Protective cover

Glass reinforced poly enclosure

IP66/IP67 automatic waterproofing
in ON and OFF positions

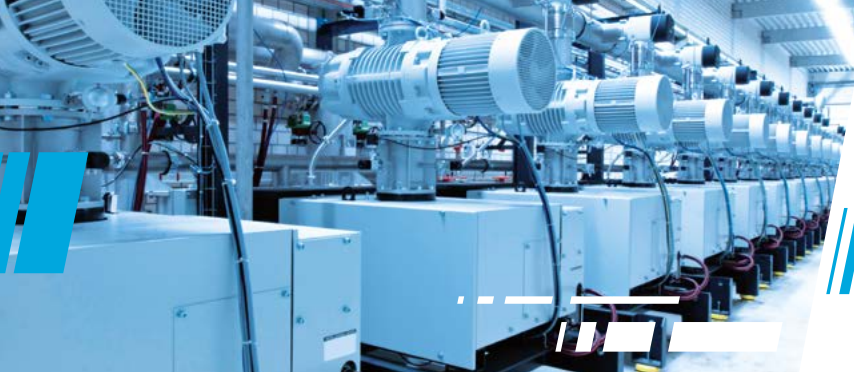

TECHNICAL CHARACTERISTICS

Mechanical endurance	> 10 000 cycles
Electrical endurance	1 500 cycles
U_i : Rated insulation voltage	1 000 V AC
U_{max} : Operational voltage	690 V
I_{the} : Conventional enclosed thermal current	40 A
U_{imp} : Rated impulse withstand voltage	8 kV
I_{cc} : Rated short-circuit breaking current capacity with gG fuses and aM fuse	100 kA
I_{cm} : Rated short-circuit making current capacity	1 kA
Cable cross-section Cu	2,5 - 10 mm ² flexible
	2,5 - 16 mm ² stranded
Degree of protection (IEC 60529)	IP66/IP67
Shock resistance (IEC 62262)	IK09
Ambient air temperature	- 25 °C/+ 60 °C

SWITCHING CAPACITY

kW/V	230 V	400 V	690 V
AC-21A/AC-22A	40 A	40 A	40 A
AC-23A	11 kW	18,5 kW	18,5 kW
AC-3	7,5 kW	11 kW	11 kW

COMPLIANT WITH IEC STANDARDS

- IEC/EN 60947-1/-3/-4/-5 :

Low-voltage switchgear and control gear:
Switches, disconnectors, switch-disconnectors
and fuse-combination units.

- Facilitates compliance:

- of electrical machinery to the European Machinery Directive 2006/42/CE, to EN 12100 and EN 60204-1 standards,
- of electrical installations to IEC/HD 60364 and NF C 15-100 standards.



PART NUMBERS

40 A

690 V

U MAX I

SEPARABLE SWITCH-DISCONNECTOR

EVO40

-  IP66/IP67
-  POLY
-  IK09
-  -25°C
+60°C
-  AC-21/AC-22
AC-23/AC-3



Voltage	Poles	Supply	Load	Straight sleeve	70° inclined sleeve	Handle	90° wall box ⁽¹⁾
200-250 V AC	2P+E	8144032	8148032	51LM0	51LM7	51LP0D21 ⁽²⁾	51LC9000
	3P+E	8144033	8148033				
	4P+E	8144034	8148034				
	6P+E	8144036	8148036				
380-480 V AC	2P+E	8144012	8148012	51LM0	51LM7	51LP0D21 ⁽²⁾	51LC9000
	3P+E	8144013	8148013				
	4P+E	8144014	8148014				
	6P+E	8144016	8148016				
500-690 V AC	2P+E	8144052	8148052	51LM0	51LM7	51LP0D21 ⁽²⁾	51LC9000
	3P+E	8144053	8148053				
	4P+E	8144054	8148054				
	6P+E	8144056	8148056				
Umax 690 V AC	2P+E	8144122	8148122	51LM0	51LM7	51LP0D21 ⁽²⁾	51LC9000
	3P+E	8144123	8148123				
	4P+E	8144124	8148124				
	6P+E	8144126	8148126				
Load side cap IP66/IP67 padlockable		Included	814A426G				

(1) Without drilling, top entry. Reversible wall box for 50° angle with bottom entry.
 (2) Gland size 5-21 mm.

Additional padlocking keys

814A541

Packaging = 10



WORLD PRESENCE

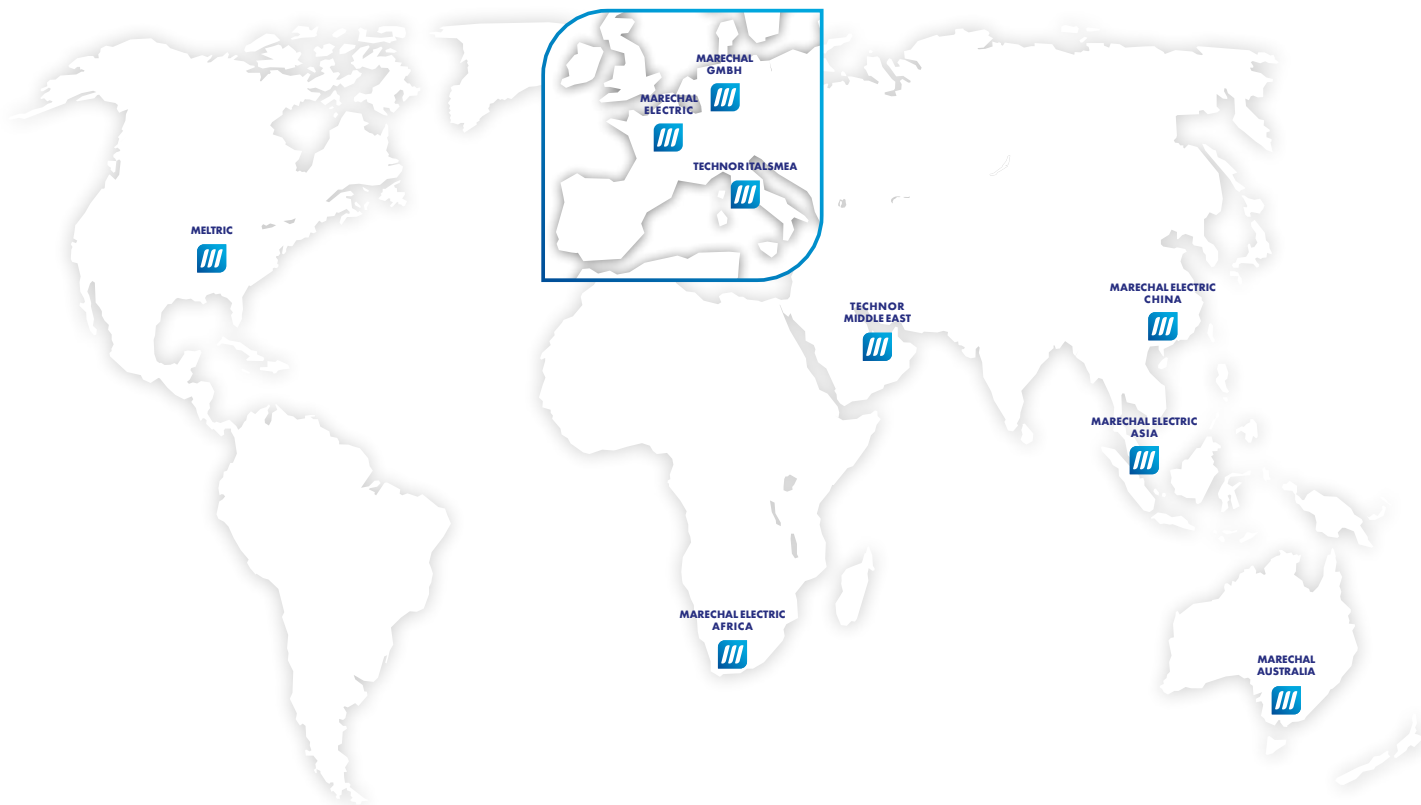

MARECHAL ELECTRIC S.A.S (Head Office)

5 avenue du chemin de Presles
94410 Saint-Maurice, FRANCE
Phone : +33 (0)1 45 11 60 00
Fax : +33 (0)1 45 11 60 60
e-mail: contact@marechal.com

Africa SADC area

MARECHAL ELECTRIC AFRICA
(PTY) LTD.
PO Box 13875 Witfield 1467
Unit A1 Harvard Lane
Aero Star Business Park
Jet Park Road, Jet Park
South Africa
Tel.: +27 11 894 7226/7/8
Fax: 086 604 1778
e-mail: sales.za@marechal.com

Asia

MARECHAL ELECTRIC Asia
Pte Ltd
9 Tagore Lane
#01-05 9@Tagore
Singapore 787472
Tel.: +65 6554 2722
Fax: +65 6455 9077
e-mail: sales.asia@marechal.com

Australia

MARECHAL AUSTRALIA PTY LTD
20 A Technology Circuit
HALLAM VIC 3803
Australia
Tél. : +61 (0)38786 2500
Fax : +61 (0)38786 2511
e-mail : sales@marechal.com.au

China

MARECHAL ELECTRIC (CHINA)
Co., Ltd
11 North Xiangshui Road,
West Dayawan District,
Huizhou.P.R.C
Tel/Fax: +86 (0)752-5319536
e-mail: sales.cn@marechal.com

Germany/Austria/Switzerland/ East Europe/Russia

MARECHAL GmbH
Im Lossenfeld 8
D-77731 Willstätt-Sand
Germany
Tel.: +49 (0)7852/91 96-0
Fax: +49 (0)7852/91 96-19
e-mail: info.de@marechal.com

Middle East

Technor Middle East DMCC
Unit No.2101, Fortune Executive
Tower, Plot No T1
Jumeirah Lakes Towers
P.O. Box 392054
Dubai, United Arab Emirates
Tel.: +971 4 362 1418
Fax: +971 4 362 1419
e-mail: sales.me@marechal.com

USA/Canada/Mexico

MELTRIC Corporation
4765 W. Oakwood Park Drive
Franklin WI 53132, USA
Tel.: +1 414 433 2700
Fax: +1 414 433 2701
e-mail: mail@meltric.com

TECHNOR

TECHNOR ITALSMEA S.p.A.
Via Italia 33,
20060 Gessate (MILANO)
Italia
Tél. : +39 02 95 00 151
Fax : +39 02 95 00 15 27
e-mail: sales@italsmea.com

For any other country or area, please contact head office.

marechal.com

 **MARECHAL
ELECTRIC**
MARECHAL® MELTRIC® RETTBOX® TECHNOR®